

TABLE OF CONTENT

PRODUCT DESCRIPTION	3
1. Proper Use	3
2. Scope of Delivery / Design	4
2.1 Scope of Delivery	4
2.2 Design	4
3. Technical Data	5
EC DECLARATION OF CONFORMITY	7
GENERAL SAFETY INSTRUCTIONS	8
1. Explanation of Safety Symbols being used in this Manual	8
2. User’s Due Diligence	9
3. Special Hazards	9
4. Basic Rules on Safety Precautions	10
5. Basic Safety Measures	10
6. Requirements concerning the Operating Personnel	10
INITIAL STARTUP	11
1. General steps for the start-up	11
2. Operating	13
2.1 Diagram of Controls and Connector Elements	13
2.1.1 Control Elements – Front Panel	13
2.1.2 Control Elements – Rear Panel	13
2.1.3 Control Elements – Hand Lamp	14
3. Functions	14
3.1 Adjusting the frequency	16
3.2 Adjusting the Phase Shift	18
3.3 Slow Motion	19
3.4 Variable Divider	20

3.5 Triggering	22
3.5.1 Internal Triggering	22
3.5.2 External Triggering	22
3.5.3 External Triggering, positive edge.....	23
3.5.4 External Triggering, negative edge.....	23
3.5.5 Trigger Level	23
3.5.6 Mains-synchronous Triggering, positive edge.....	24
3.5.7 Mains-synchronous Triggering, negative edge.....	24
3.6 Power Stages	25
3.7 Trigger Output.....	26
3.8 Calibration Touch Panel.....	27
3.9 Serial Interface via USB	27
MAINTENANCE	27
1. Storage.....	27
2. Maintenance	28
3. Inspection / Calibration	28
4. Repairs / Disposal.....	28
ANNEXE	29
1. Socket IN.....	29
2. Socket OUT.....	29
3. Socket MULTI	29
4. Socket Hand Lamp.....	29
5. Installing and Replacing the Flash Tube.....	30
ADDITIONAL INFORMATION	31
1. Explanation of Terms	31
2. Spare Parts	31

PRODUCT DESCRIPTION

1. Proper Use

The HELIO-STROB master is a stroboscope (light flashing instrument) for industrial applications. This instrument is used to produce snapshots of sequences which, due to the rapidity with which they proceed, are not perceivable by the human eye.



Please note that operating the instrument in explosion-hazardous environments is strictly forbidden.

Appropriate use also includes reading and understanding these operating instructions and complying with the information given in them, especially the safety information. This also includes carrying out all the inspection and maintenance work at the specified intervals.

The operation of stroboscopes may cause failure or interference of nearby radio devices or radio service. In this case, suspend the operation of the instrument. As a basic principle, keep the operation of the instrument as short as possible.

To avoid personal injury or damage to the equipment, only qualified, trained and authorised personnel should operate the HELIO-STROB master.

Safe operation cannot be assured if the HELIO-STROB master is not used in accordance with the above definition of appropriate use.

The user, not the producer, shall assume any liability related to any personal injury or material damage resulted from the inadequate use of the instrument.

2. Scope of Delivery / Design

2.1 Scope of Delivery

The standard scope of supply consists of the following components:

- control unit
- hand lamp with connecting cable incl. flash tube
- USB cable, A/St – B/St
- mains cable
- Allen wrench 2.5 mm
- operation manual

Please check if the scope of supply is complete!

2.2 Design

The instruments are designed and manufactured according to acknowledged safety rules and the current state of the art.

The basic design of HELIO-STROB master consists of the following components:

Case (control unit)	sturdy aluminium housing with adjustable handle
Case (hand lamp)	full-metal case with tripod mount and handle
Power supply	110 V / 230 V 50-60 Hz adjustable by means of voltage selector
Operation	touch panel and turning knob
Display	LC-display
Connection	cable connections (pluggable)
Control Unit / Hand lamp	cable length 2 m (standard)
Signal In- and Output	BNC connector and diode connector



To avoid personal injury and damage to the equipment, repairs must be only performed by professionally trained technicians authorised by ELMED. Take special care when opening the device and/or the hand lamp, since it is possible to touch parts carrying a voltage that is considerably higher than the supply voltage.

3. Technical Data

HELIO-STROB master

Power supply	115/230 VAC 50/60 Hz (switchable)
Power consumption	approx. 150 W
Dimensions of the case	280 x 240 x 80 mm ³ (control unit) 182,5 x 117 x 117 mm ³ (hand lamp excl. handle)
Weight	approx. 2.8 kg (control unit) approx. 1.5 kg (hand lamp)
Light source	flash tube in separate hand lamp, pluggable, installed
Internal control of the flash rate	turning knob and touch panel
External control of the flash rate	pos. impulses 50 mV to 30 V, triggering edge individually adjustable
Internal frequency range in Hz / fpm	1 - 315 Hz / 60 - 18900 fpm
External frequency range in Hz / fpm	1 - 8000 Hz / 60 - 480000 fpm, incoming flash rates > 335 Hz are split integrally
Measurement duration	0.33 s (min. 1 periode)
Measuring value display	LC-display, height of digits 10 mm
Display in	Hz / fpm
Display resolution	0.01 Hz / 0.1 fpm
Phase shifting in	degree / ms
Phase shifting	0° - 540° / 0 - 999.99 ms
Resolution degree / ms	0.1° / 0.001 - 0.01 ms
Slow motion	Hz / fpm
Resolution Hz / fpm	-5 Hz - +5 Hz / -300 fpm - +300 fpm
Display resolution	0.01 Hz / 0.1 fpm
Variable transformation ratio (external triggering)	1:10 - 10:1
Resolution	0.001
Light output	max. 3 Ws *further information in the diagram on previous page
Light intensity	max. 9600 Lux (distance: 50 cm)
Precision	0.01 % ± 1 Digit
Operating temperature	0°...+40°C
Storage temperature	-20° ... +60°C
Air humidity	80% relative air humidity at 30°C

*Further information – Light output

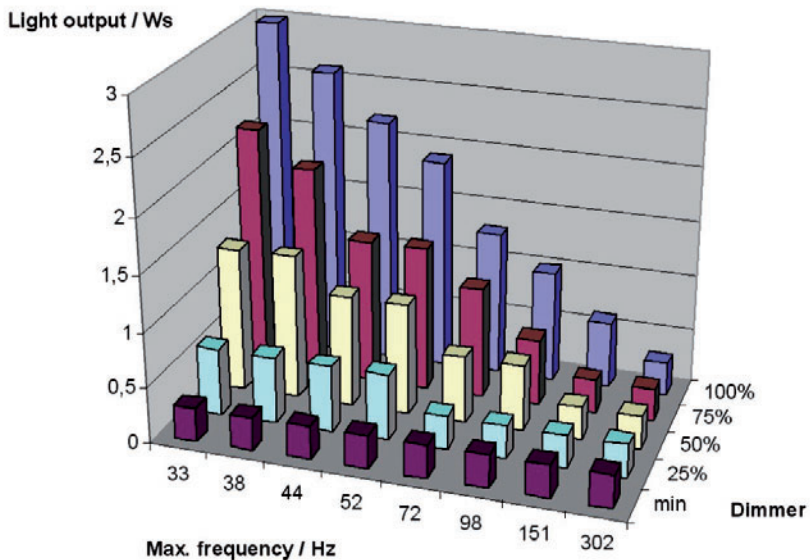

In the brightness level 0 (min.) the stroboscope works with minimal energy.

EC DECLARATION OF CONFORMITY

It is herewith confirmed that the product listed below

HELIO-STROB master

meets the safety requirements within the scope of the conformity evaluation procedure of the related competent authority, which are defined in the regulation 2004/108/EG of the European Council for the approximation of laws of the member states with respect to electromagnetic compatibility. The same applies to the provisions of the law on electromagnetic compatibility of instruments (EMVG) as of 9 November 1992.

This declaration applies to all units that are manufactured in accordance with the appropriate manufacturing documentation which is part of this declaration.

For the evaluation of products regarding the electromagnetic compatibility relevant harmonized standards have been used.

DIN EN 61000-6-1

DIN EN 61000-6-3

Design-engineering modifications that have such significant effects on the technical specifications and the proper use defined in this operation manual so as to change the instrument considerably shall nullify this declaration of conformity.

This declaration shall be legally binding for the manufacturer.

ELMED Dr. Ing. Mense GmbH, Heiligenhaus

signed by

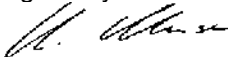

Claudia Mense

Managing Director

Heiligenhaus, 11.03.2013

GENERAL SAFETY INSTRUCTIONS

1. Explanation of Safety Symbols being used in this Manual

The following symbols are used in these operating instructions:

- Safety symbols indicate the presence of adjacent safety notes.
- Special symbols indicate important information that should strictly be observed.

This symbol indicates that the relevant action imposes a hazard for life and limb.



This symbol indicates information provided for improving the understanding of processes.



2. User's Due Diligence

The HELIO-STROB master has been developed and manufactured in consideration of hazard analyses and in compliance with the relevant harmonised standards as well as the additional technical specifications. Therefore, the HELIO-STROB master is a state-of-the-art instrument and offers a maximum of safety. This safety can be achieved only if all required safety precautions have been taken. Subject to due diligence, the user of this instrument shall plan such precautions and supervise their execution.

The user shall particularly ensure that



- the HELIO-STROB master is used properly (see Chapter "PRODUCT DESCRIPTION")
- the instruments are operated only if in perfect, fully functional condition
- the operation manual of the instruments is at all times legible and complete on the site of operation.
- the instruments are operated only by adequately qualified and authorised personnel which is regularly trained in all aspects related to occupational health and safety; this personnel knows and follows the operation instructions, especially the relevant safety regulations contained therein
- all safety and warning labels are clearly legible and none of them are removed from the instrument.

3. Special Hazards

	<p>In case of users with a neurological proneness to epileptic seizures, the light effects produced by a stroboscope may cause photo-induced epilepsy. Users with such predisposition must not use stroboscopes!</p>
---	---

	<p>Safety Guidelines for people wearing active implants When using stroboscopes, an influence of active implants (e.g. pacemakers) cannot be completely excluded. For safety reasons we recommend that people wearing active implants are excluded from working with stroboscopes. Persons wearing active implants have expressively to be instructed in this regard.</p>
---	--

4. Basic Rules on Safety Precautions

	Within professional organisations the employer / entrepreneur has to inform the employees / insured workers about the possible hazards related to their work and the safety precautions to be applied. This shall include the current findings regarding hazard avoiding procedures and eyelid protective reflexes.
	

- Do not look into the flash tube directly and unprotected as this could be dangerous for the eyes – especially over longer periods of time.
- Due to the dazzle effects caused by the flashlight at short distances, the ability to see may be disturbed in such manner as to make orientation impossible.
- Flashlight shall not be directed to the eyes of other persons.

5. Basic Safety Measures

The basic safety guidelines and regulations of the corresponding professional associations and organisations shall apply.

Before starting up the HELIO-STROB master, the user must check that the stroboscope, the connection cables and the plugs are undamaged and in perfect working order.

	Take special care when changing the flash tube. The flash tube gets very hot in use – danger of burns! Before touching the flash tube to change it, let it cool down and take the following safety measures: <ul style="list-style-type: none">- switch off the stroboscope- disconnect the controller from the mains (by pulling out the mains power cable)- let the flash tube to cool down for at least 5 minutes before removing the reflector housing.
--	--

6. Requirements concerning the Operating Personnel

The HELIO-STROB master may only be used by persons who have suitable been instructed and authorized. These persons must have read and understood the operating instructions, in particular the section “GENERAL SAFETY INSTRUCTIONS” (pages 8 to 10), and then act accordingly.

They must have been instructed in the basic principles of health and safety at work and accident prevention.

INITIAL STARTUP

In order to prevent injury or damage when starting up the HELIO-STROB master, it is essential to comply with the following points: The device may only be started up by suitably qualified persons and with due regard for the safety information given here.



Do not use any parts that have been damaged!

1. General steps for the start-up



The HELIO-STROB master is designed for power system types TN-C and TN-S.



These power supply types provide for the immediate switch off of the supply voltage if a contact occurs between supply voltage and grounded components of the instrument.

If operated within power systems other than the above, the user shall be liable for the electric safety. (voltage range, s. “PRODUCT DESCRIPTION - 3. Technical Data”).

Prior to switching on the instrument, check the correct setting of the voltage selector ⑨.

The value set by the voltage selector ⑨ must coincide with the level of the supply voltage.

The incorrect setting of the voltage selector ⑨ causes damage to the instrument.

- Before the initial start-up install the flash tube into the hand lamp. Please follow the instructions in chapter “ANNEXE - 5. Installation and change of the flash tube” on page 30.
- Connect the hand lamp to the control unit: Plug in the plug of the hand lamp cable into the corresponding socket ⑦ on the back of the control unit and lock it in place. Turn the switch of the hand lamp so that it is ready for operation.
- Connect the control unit to the mains power: Plug in the plug of the mains cable into the corresponding socket ⑧ at the back of the controller and connect the earthing contact plug of the mains cable to the mains socket.

- Switch on the device at the mains switch ⑧ at the back of the control unit. The last set values of frequency / rotation speed, phase shift, etc. are loaded and shown on the LC-display ⑤. The HELIO-STROB master is ready for operation.
- By turning the switch on the back of the hand lamp on or off, the flash frequency is activated or interrupted.

	<p>In order to protect the hand lamp against thermal destruction the flash production is automatically interrupted at the maximum permissible operating temperature. The hand lamp continues operating after a cooling phase.</p>
---	---

Depositing of the hand lamp:

Correct!



Wrong!



2. Operating

2.1 Diagram of Controls and Connector Elements

2.1.1 Control Elements – Front Panel

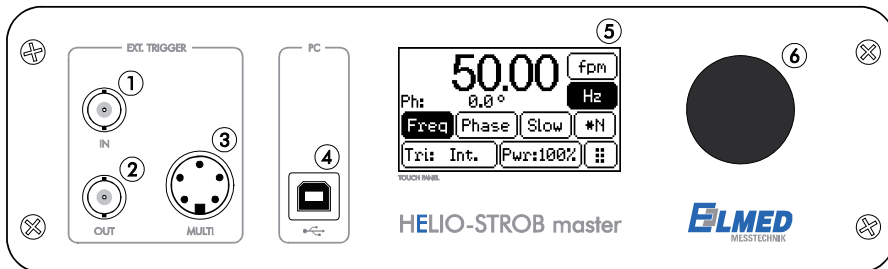

- ① Trigger input
- ② Trigger output
- ③ Multifunction jack
- ④ USB socket
- ⑤ Touch screen with LC display
- ⑥ Turning knob

2.1.2 Control Elements – Rear Panel

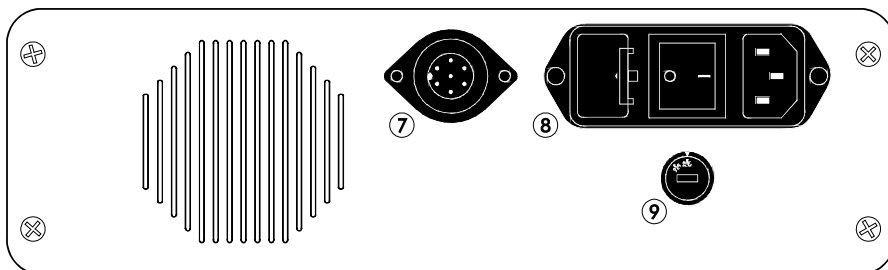

- ⑦ Connection of hand lamp
- ⑧ Combined element power switch / power connector / 2 x Fuse (1 A / slow)
- ⑨ Voltage selector

2.1.3 Control Elements – Hand Lamp



3. Functions

Buttons of the touch panel

[Freq]	flash frequency
[Phase]	phase shift
[Slow]	slow motion
[*N]	multiplier
[⋮]	display keypad
[fpm]	display in “flashes per minute”
[fps]	display in “flashes per second”
[ms]	display in milliseconds - phase
[°]	display in degree - phase
[0] [1] [2] [3] [4] [5] [6] [7] [8] [9]	keypad
[✓]	confirmation of entry / data transfer of measured frequency
[:]	entry of division ratio
[.]	decimal point
[C]	edit / delete
[*↑]	increase multiplier
[*↓]	decrease multiplier
[#1]	return to initial frequency



	abort
	sign of slow motion value
	setting the trigger mode: internal mode
	setting the trigger mode: external mode, trigger level, positive edge
	setting the trigger mode: external mode, trigger level, negative edge
	setting the trigger mode: mains-synchronous, positive edge
	setting the trigger mode: mains-synchronous, negative edge
	internal triggering
	external triggering, positive edge
	external triggering, negative edge
	mains-synchronous triggering, positive edge
	mains-synchronous triggering, negative edge
	power incl. indication of status
	direct entry of power stage

	<p>All functions are selected by touching the relevant buttons on the touch panel ⑤. Active functions and options are invertedly displayed.</p> <p>Any value in the first line (large numbers) can be entered or changed via the <u>turning knob</u> ⑥ or alternatively by means of the <u>keypad</u> on the touch panel (selection of the keypad see below).</p> <p>Rapid rotation of the turning knob: the value is changed in large steps Slow rotation of the turning knob: the value is adjusted in small steps (fine adjustment).</p> <p>In the lower line of the display a further value is displayed in smaller characters – i.e. when setting the frequency the current value of the phase shift is also indicated.</p>	
	touch panel	turning knob
	press	turn

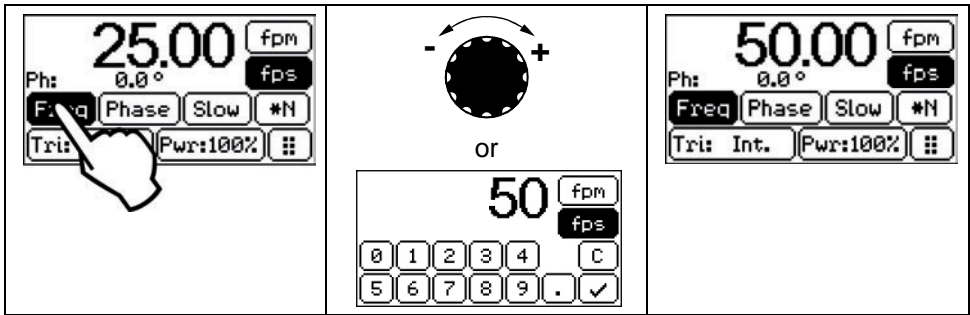
3.1 Adjusting the frequency

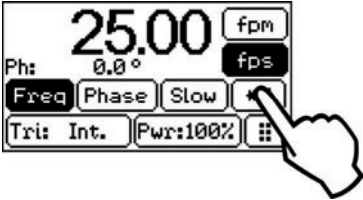

[Freq]	select flash frequency mode
fpm	display in [fpm] – flashes per minute
fps	display in [fps] – flashes per second
●	setting a value fpm / fps
⏏	select keypad
0 1 2 3 4 5 6 7 8 9	direct entry in decimal numbers fpm / fps
.	decimal point
C	edit / delete
✓	confirmation of entry
X	abort
i	For the determination of revolution speeds or frequencies start with the maximum value (flashes) and then slowly reduce the frequency until the test object seems to stand still. WARNING: When you start with the lowest frequency you risk determining a frequency that is too low. The reason for this is that the test object already seems to stand still when the frequency is divided by an integer factor (i.e. by two). In order to check the measured value in the internal trigger mode please proceed as follows:

		
	[*N]	control and doubling of flash frequency
	[*↑]	increase flash frequency (10 times at maximum)
	[*↓]	reduce flash frequency
	[*1]	return to initial frequency
	[✓]	adoption of the measured frequency
	<p>The indication (max) in the second line on the display shows that the frequency cannot be further increased by means of the multiplier [*↑].</p>	

3.2 Adjusting the Phase Shift

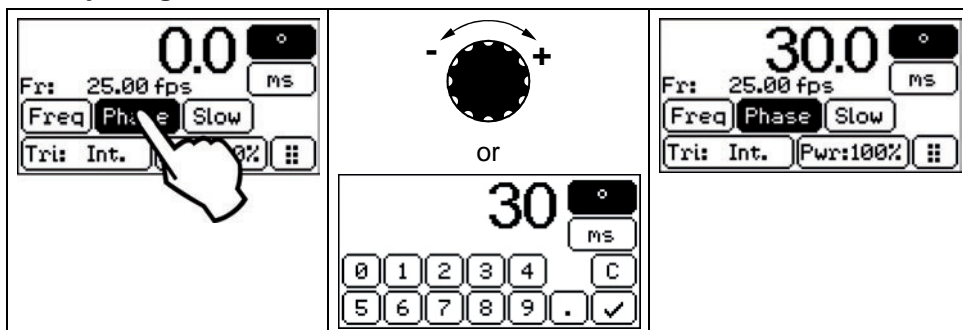

Phase	select phase shift mode
◊	display in degree
MS	display in milliseconds
●	setting a value degree / ms
⋮	select keypad
0 1 2 3 4 5 6 7 8 9	direct entry in decimal numbers degree / ms
.	decimal point
C	edit / delete
✓	confirmation of entry
X	abort



Using the phase shift a delay between the trigger signal and the flash can be set. This permits the observation of the test object in specific states of motion. Regardless of the speed frequency, the observed object always appears in the same position, when the setting is in degree.

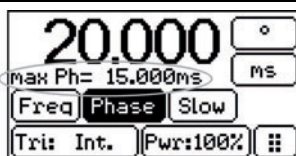

In case a delay is set in milliseconds corresponding to a phase shift greater than 540° , a respective message appears in the second line of the display, alternating with the standard display (s. picture).

3.3 Slow Motion

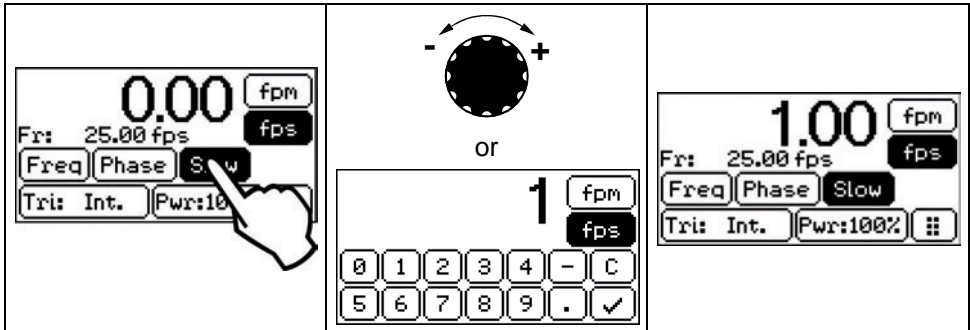

	select slow motion mode
	display in [fpm] - flashes per minute
	display in [fps] - flashes per second
	setting a value fpm / fps using the turning knob
	select keypad
	direct entry in decimal numbers fpm / fps
	decimal point
	signed slow motion value
	edit / delete
	confirmation of entry
	abort



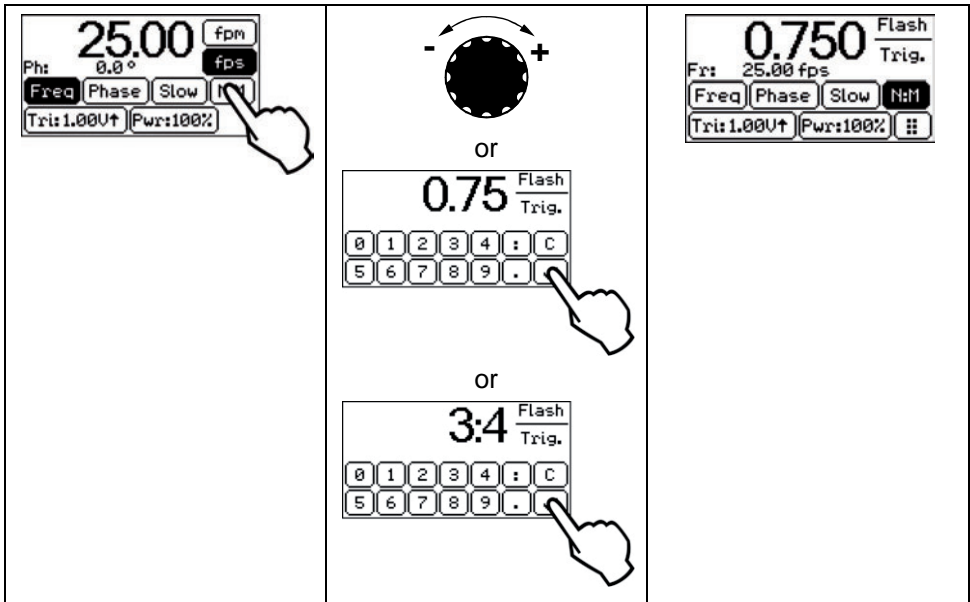

i By means of the slow motion function the complete motion sequence may be observed. You get the visual impression that the test object is continuously moving slowly. Select the speed and moving direction between +5 Hz and -5 Hz (beat frequency).

3.4 Variable Divider

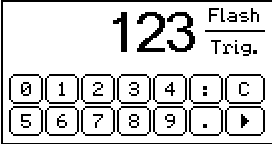
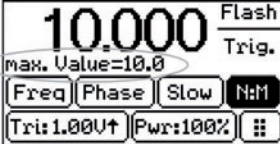
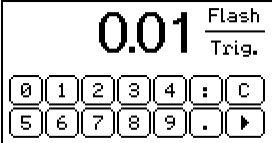

		select mode "variable divider"
		setting of divider in decimal numbers
		select keypad
		direct entry of divider in decimal numbers / division ratio
		entry of divider as ratio
		decimal point
		edit / delete
		confirmation of entry
		abort
	<p>The external trigger frequency is modified by the divider. The factor can be entered as a decimal number in the range of 0.1 to 10.0 or as a division ratio (e.g. 12:60). The function "variable divider" permits to use e.g. the trigger signal of an encoder on a motor shaft in order to get a freeze image of a rotary shaft connected via a gear box.</p>	

Instructions for entering “Variable Divider”

	<p>Exceeding the limiting value of 0.1 to 10.0</p>	
	<p>Falling below the limiting value of 0.1 to 10.0</p>	
	<p>If the entered factor exceeds or falls below the acceptable range, a corresponding message appears during 4 seconds in the display. In case the factor is smaller than 0.1 or greater than 10.0, the smallest respectively greatest possible factor is automatically set.</p>	
	<p>In case the flash frequency - due to the set factor (<1 Hz) - falls below the acceptable range, the symbol “<” is added before the frequency. In case the resulting flash frequency exceeds the acceptable range (> 335 Hz), there is no warning, but the frequency is automatically divided by integral numbers.</p>	

3.5 Triggering

i	The trigger mode and the trigger level are displayed in the corresponding field of the main menu. By setting this field a submenu is selected for setting or changing the trigger mode.
----------	---

3.5.1 Internal Triggering

i	The stroboscope generates the flash frequency.		
	Tri: Int.		select trigger mode
	Int.		select option "internal triggering"
	<input checked="" type="checkbox"/>		confirmation of entry

3.5.2 External Triggering

i	<p>The frequency is determined by the signal that is connected to the BNC socket ① or the multifunctional socket MULTI ③ (see chapter "PRODUCT DESCRIPTION - 3. Technical Data" and "ANNEXE - 1. Socket IN, 3. Socket MULTI"). When applying an external trigger signal make sure that the signal level and the frequency do not fall below or exceed the permissible values of the HELIO-STROB master (see chapter "PRODUCT DESCRIPTION – 3. Technical Data"). In this case the stroboscope follows the external clock. If there is no external trigger signal or if the frequency of the external trigger source is less than 1 Hz, this message "-.-" will be shown on the display. In the case of external signals > 0 Hz the stroboscopes flashes according to the external clock rate. Frequencies > 335 Hz to 8000 Hz are divided as whole numbers. The undivided frequency of the external clock is shown in the display.</p> <p>The selection of one of the external trigger modes activates the trigger level. Using the turning knob the level can be set between 50 mV and 5 V in order to e.g. suppress disruptive noises.</p>
----------	---

3.5.3 External Triggering, positive edge

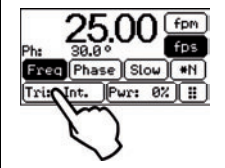
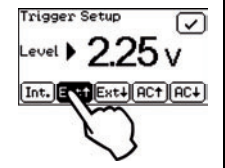
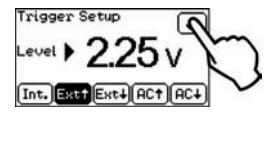
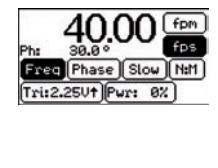
			
	Tri: Int.	select trigger mode	
	Ext+	select option "external triggering, positive edge"	
	<input checked="" type="checkbox"/>	confirmation of entry	

3.5.4 External Triggering, negative edge

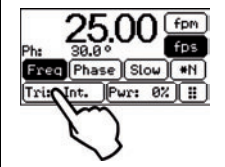
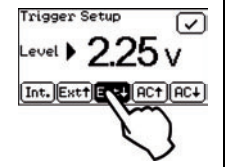
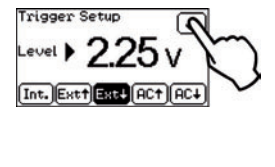
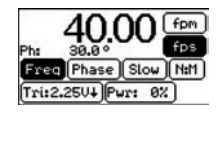
			
	Tri: Int.	select trigger mode	
	Ext-	select option "external triggering, negative edge"	
	<input checked="" type="checkbox"/>	confirmation of entry	

3.5.5 Trigger Level

	<input type="radio"/>	setting the trigger level
	<input checked="" type="checkbox"/>	confirmation of entry

3.5.6 Mains-synchronous Triggering, positive edge

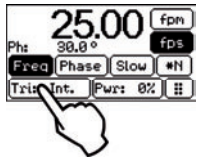
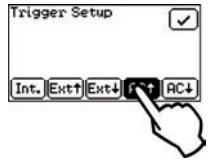
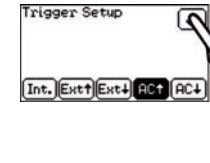
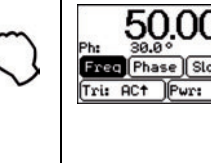
	<p>The frequency of the mains determines the flash frequency. This mode is suitable for the observation of objects which move mains-synchronously. This partly applies to movements, that correspond to a multiple or part of the mains frequency.</p>		
			
<input type="text" value="Tri: Int."/>	select trigger mode		
<input type="button" value="AC↑"/>	select option “mains-synchronous triggering, positive edge”		
<input checked="" type="checkbox"/>	confirmation of entry		

3.5.7 Mains-synchronous Triggering, negative edge

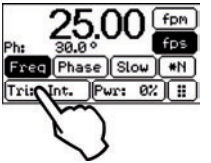
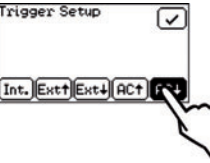
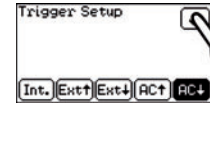
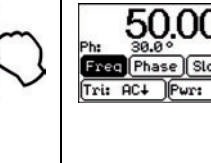
			
<input type="text" value="Tri: Int."/>	select trigger mode		
<input type="button" value="AC↓"/>	select option “mains-synchronous triggering, negative edge”		
<input checked="" type="checkbox"/>	confirmation of entry		

3.6 Power Stages



The stroboscope automatically adjusts the power to the flash frequency. By setting different power levels, the brightness can be individually adjusted. The corresponding field on the display opens a submenu. The output can be set within the minimum and maximum value either by using the turning knob or by touching the bar display. (see chapter “PRODUCT DESCRIPTION – 3. Technical Data”).

	<p>or</p>		
	<input type="text" value="Pwr:100%"/>	select power mode	
		value setting	
		direct entry of power stage	
	<input checked="" type="checkbox"/>	confirmation of entry	

3.7 Trigger Output



The HELIO-STROB master is equipped with a trigger output to control e.g. different devices. The signal that is supplied to the sockets OUT ② and MULTI ③ (see chapter "PRODUCT DESCRIPTION - 3. Technical Data", "ANNEXE - 2. Socket OUT, 3. Socket MULTI") corresponds to the TTL level. The period duration depends on the flash rate, T_{Low} is constant ($200\mu s$). If the stroboscope is controlled by an external signal, the output frequency will correspond to the input frequency up to 335 Hz. For frequencies >335 Hz up to 8000 Hz a signal that is divided in integer numbers is supplied to the trigger output. This signal corresponds to the actual flash frequency of the stroboscope. The actual frequency of the external signal is shown on the display.

Signal sequence:

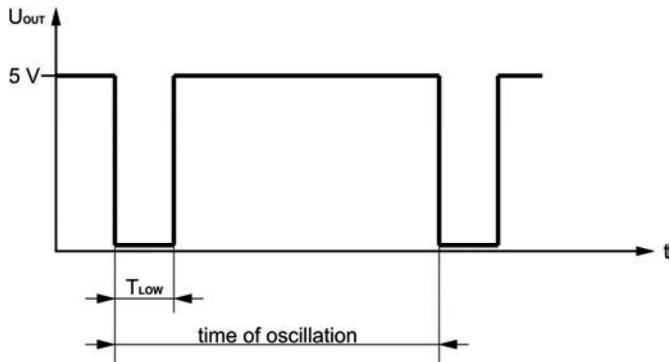

3.8 Calibration Touch Panel

A recalibration of the touch panel may be necessary, e.g. due to aging of the pads or failure to contact. For a recalibration please proceed as follows:

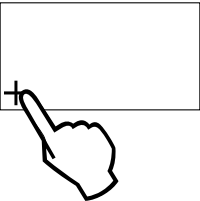
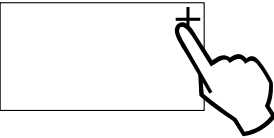
		
After turning on the stroboscope touch the display for about 5 seconds.	Touch the cross that appears in the bottom left corner.	Touch the cross that appears in the upper right corner. Recalibration done!

3.9 Serial Interface via USB

Via the serial interface ④ the HELIO-STROB master can be computer-controlled. It is also possible to update the firmware via the serial interface.

Further information on controlling via PC and firmware updating can be found on our Internet service page:

URL: <http://support.elmed.eu/helio/>
Username: helio
Password: 8yBMJoDQ

MAINTENANCE

1. Storage

- Protect the instrument from damage by properly storing it in a dry room.
- To avoid condensation see that the storage temperature is kept.
Storage temp.: -20°C ... +60°C (warming time constant >10K/h)

2. Maintenance

According to the design, the HELIO-STROB master is not susceptible to disturbance. However, the following should be basically observed:

- Do not throw the instrument or expose it to heavy impacts.
- Store the instrument protected from damage.
- Clean the instrument by using only a soft, lightly-moist cloth. Use only mild detergents.

3. Inspection / Calibration

To maintain the reliability and the high quality standard of the HELIO-STROB master over a long period of time, the instrument should be inspected by the manufacturer each year. During inspections, all the specific functions of the instrument are checked. A PTB (Physikalisch-Technische Bundesanstalt, the German Bureau of Standards) traceable manufacturer certificate is available on request. The results of inspections shall be documented in inspection sheets and stored in a database.

4. Repairs / Disposal

Instruments that are damaged or do not perform according to their specifications shall not be used anymore. To provide a safe and functional instrument, only original spare parts shall be used for repair.



To dispose of the old instrument according to legal rules and provisions, please send the HELIO-STROB master to the manufacturer.

If your instrument requires inspection / repair or disposal, please send the unit DDU to:

ELMED Dr. Ing. Mense GmbH
Stroboscope-Service
Weilenburgstr. 39
D-42579 Heiligenhaus



Proper execution of maintenance and repair is guaranteed only by the manufacturer or by qualified and authorised service centres.

ANNEXE

1. Socket IN

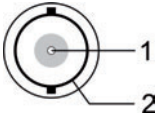
socket	pin	description
	1	trigger IN
	2	0 V (ground)

2. Socket OUT

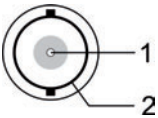
socket	pin	description
	1	trigger OUT
	2	0 V (ground)

3. Socket MULTI

socket	pin	description
	1	0 V (ground)
	2	+5 VDC (output)
	3	+12 VDC (output)
	4	trigger OUT
	5	trigger IN

4. Socket Hand Lamp

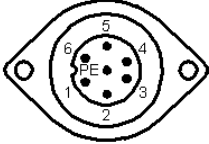
socket	pin	description
	1	anode voltage
	2	unoccupied
	3	ignition
	4	115 / 230 VAC
	5	115 / 230 VAC
	6	cathode voltage
	PE	protective conductor

5. Installing and Replacing the Flash Tube



To avoid personal injury or damage to the equipment, install only approved flash tubes in this stroboscope. Unapproved flash tubes could cause a fire or explosion.

The flash tube is a wearing part that must be replaced sooner or later depending on the intensity of the usage. Unlike a glow lamp, in which a defect can easily be detected (burnout), the indication of a flash tube defect can be different:

- reduced brightness
- unsteady light (flickering)
- discoloured bulb jacket

To install respectively replace the flash tube, please proceed as follows:

- Switch off the stroboscope and pull out the power plug from the mains socket.
- Disconnect the hand lamp from the control unit.
- If you have operated the flash tube before, you must wait for at least 5 minutes before executing the next steps for the flash tube to cool down.
Danger of burns!
- Remove the surrounding edge protection and loosen the four mounting screws of the protective glass. Use the supplied Allen wrench. The protective glass can now be taken out along with the reflector. Caution: For safety against electric shocks, the reflector is connected to the housing by a grounding cable. This connection must not be undone!
- Remove the old flash tube from the socket by carefully pulling the flash tube on the bulb.
- Take the new flash tube out of the packing. Avoid touching the lamp jackets with the fingers. Insert the flash tube into the base. While inserting the flash tube, touch only the stud bolts or the installation ring. The connecting points are arranged such that wrong polarity of the flash tube can be ruled out completely. Insert the new flash tube completely into the base; otherwise there may be reduced brightness or lack of uniformity in the light intensity.
- Install the protective glass containing the reflector properly with the help of the four mounting screws. **Important!** Please check whether the flash tube is in the centre of the reflector cut-out. Under no circumstances should the flash tube have direct contact to the reflector, otherwise there can be **malfunctions!**
- Please also check the silicon ring in the reflector for damages; it provides protection against flashover between flash tube and reflector.
- Finally, replace the edge protection on the hand-held lamp housing.

ADDITIONAL INFORMATION

1. Explanation of Terms

Terms	Explanation
triggering	trigger impulses for the flash rate
rising edge	(internal / external)
falling edge	The flash tube flashes at a change in the trigger signal from "0" to "1".
flash rate	The flash tube flashes at a change in the trigger signal from "1" to "0".
display	number of flashes per time unit
fpm	display for indication of set values
fps	frequency per minute of the observed object
phase shift	frequency per second of the observed object
slow motion	positioning of the observed object to any observation point (0° - 540°)
variable transformation ration	constantly changing phase shift
trigger level	factor by which an external trigger signal is multiplied

2. Spare Parts

Part.-No.	Description
0320340000	Flash tube for HELIO-STROB master, pluggable
0365100012	Protective glass for HELIO-STROB master
0310610050	5- pole plug (for socket "MULTI")
4170310100	fuse 1 A / delay action

